

Part Number: PT347-03140

Kit Contents

Item #	Quantity Req.	Description
1	1	Convenience Net

Hardware Bag Contents

Item #	Quantity Req.	Description

Additional Items Required For Installation

Item #	Quantity Req.	Description

Conflicts

None

Recommended Tools

Personal & Vehicle Protection	Notes
None	
Special Tools	Notes
None	
Installation Tools	Notes
None	
Special Chemicals	Notes
None	

General Applicability

All

Recommended Sequence of Application







Item #	Accessory

*Mandatory

Vehicle Service Parts (may be required for reassembly)

Item #	Quantity Req.	Description

Legend

	STOP: Damage to the vehicle may occur. Do not proceed until process has been complied with.
	OPERATOR SAFETY: Use caution to avoid risk of injury.
	CAUTION: A process that must be carefully observed in order to reduce the risk of damage to the accessory/vehicle and to ensure a quality installation.
	TOOLS & EQUIPMENT: Used in Figures calls out the specific tools and equipment recommended for this process.
	REVISION MARK: This mark highlights a change in installation with respect to previous issue.
	SAFETY TORQUE: This mark indicates that torque is related to safety.

Care must be taken when installing this accessory to ensure damage does not occur to the vehicle. The installation of this accessory should follow approved guidelines to ensure a quality installation.

These guidelines can be found in the "Accessory Installation Practices" document.

This document covers such items as:-

- Vehicle Protection (use of covers and blankets, cleaning chemicals, etc.).
- Safety (eye protection, rechecking torque procedure, etc.).
- Vehicle Disassembly/Reassembly (panel removal, part storage, etc.).
- Electrical Component Disassembly/Reassembly (battery disconnection, connector removal, etc.).

Please see your Toyota dealer for a copy of this document.

1. Installation of Cargo Net.

- (a) Open the trunk and locate the anchor locations on the passenger's side of the vehicle (Fig 1-1).

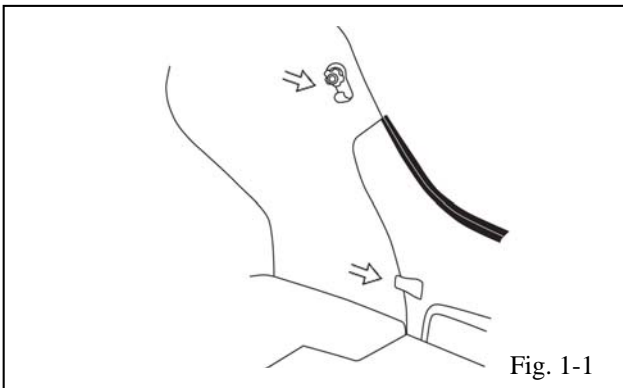

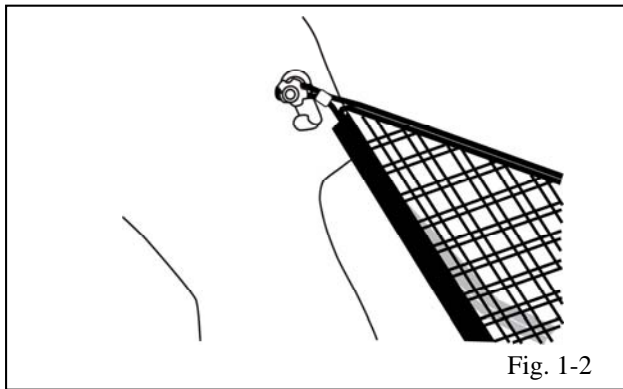

-  (b) With the net handle facing out toward the rear of the vehicle, attach the loop at the top of the net to the vehicle anchor as shown (Fig. 1-2).

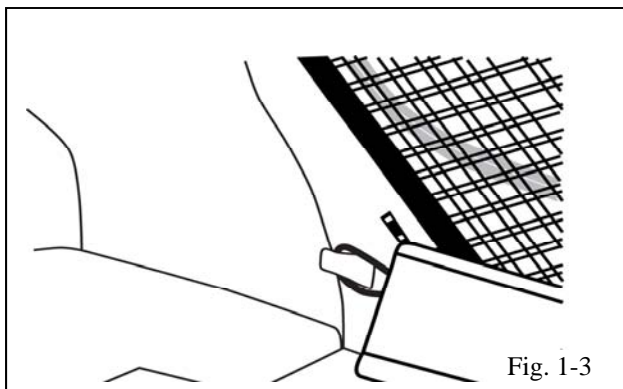

- (c) Attach the loop at the bottom of the net to the vehicle as shown (Fig. 1-3).
- (d) Repeat steps 1(a) through 1(c) for the opposite side of the vehicle.

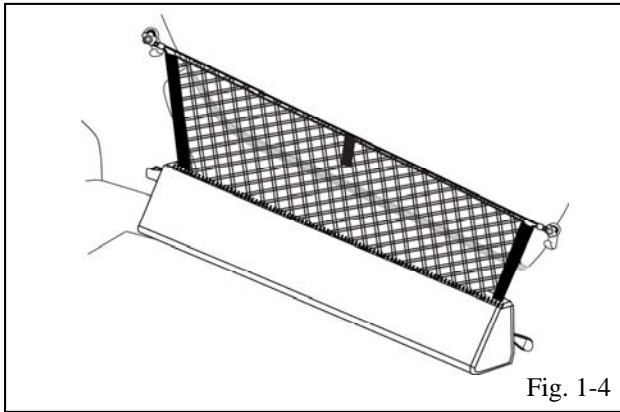



-  (e) Confirm the completed assembly. Make sure the net handle is facing out toward the rear of the vehicle (Fig. 1-4).

Checklist - these points **MUST** be checked to ensure a quality installation.

<u>Check:</u>	<u>Look For:</u>
<p><u>Accessory Function Checks</u></p> <p><input type="checkbox"/> Confirm that the net is attached properly to the anchor points in the vehicle.</p>	<p>Make sure the loops are attached to the vehicle anchors at the top and bottom. The net handle should face out toward the rear of the vehicle.</p>
<p><u>Vehicle Function Checks</u></p> <p><input type="checkbox"/> Vehicle door operation</p>	<p>Confirm vehicle door opens and closes without interference from Cargo Net.</p>
<p><u>Vehicle Appearance Check</u></p> <p><input type="checkbox"/> After accessory installation and removal of protective cover(s), perform a visual inspection.</p>	<p>Ensure no damage (including scuffs and scratches) was caused during the installation process (For PPO installations, refer to TMS Accessory Quality Shipping Standard).</p>